

VALIGIE HERMETIC · ART. TX40

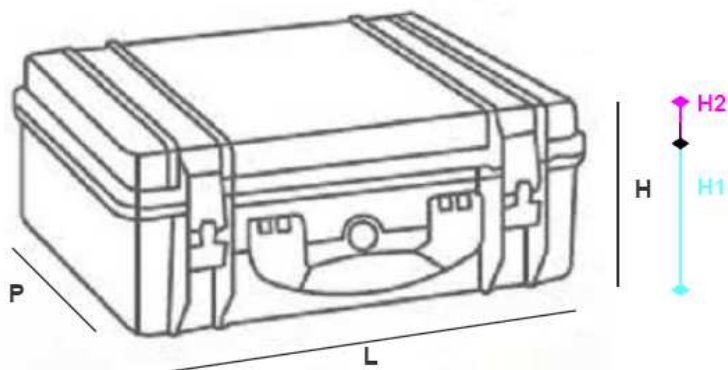

	L	P	H	H1	H2
external	405	330	165	-	-
internal	375	265	-	105	45

HIGH PERFORMANCE RESINS

COLORS



WEIGHT

art. TX40/U = 3,8 kg · art. TX40/S = 2,4 kg · art. TX40/V = 2,0 kg